

INSTALLATION INSTRUCTIONS

PLT4002/PLT4003/PLT4004/PLT4005
OSMF90S/OSMF100S/OSMF12/90S

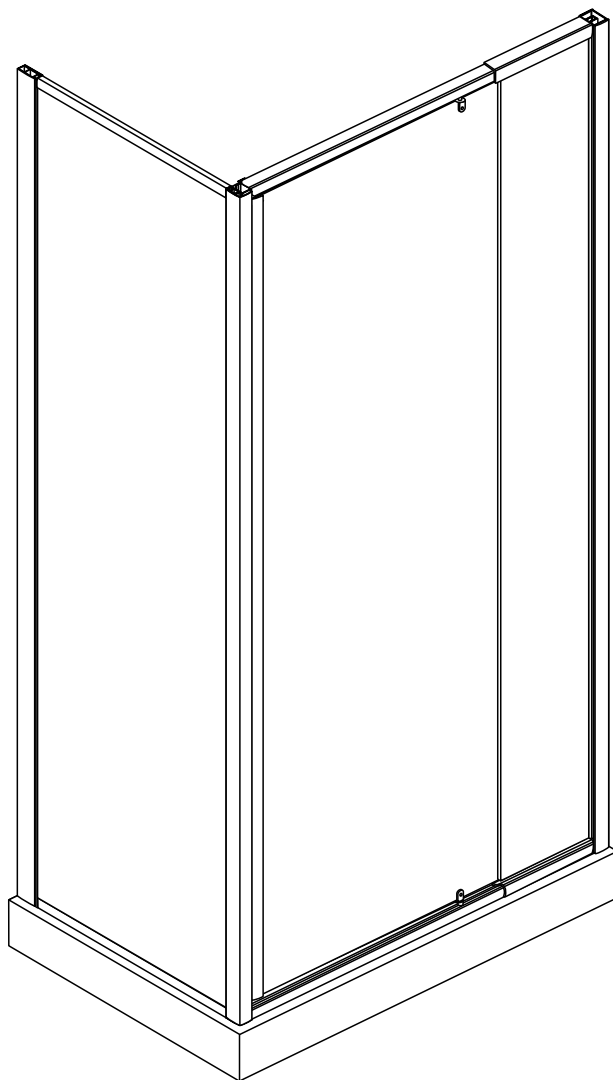

◆ General Information

Please inspect the product immediately upon receipt for transit damage, missing packs/parts or manufacturing fault. Damage reported later cannot be accepted. Please handle the product with care avoiding knocks and shock loading to all sides and edges of the glass.

Notes: Safety glass can not be re-worked.

Please read these instructions carefully before start of installation.

Special care should be taken when drilling walls to avoid hidden pipes or electrical cables.

Note: This product is heavy and may require two people to install.

Aftercare instructions

After use, your shower should be cleaned with soap and water. This is particularly important in hard water districts where insoluble lime salts may be deposited and allowed to build up.

Cleaners of a gritty or abrasive nature should not be used. Care should be taken to avoid contact with strong chemicals such as organic solvents and strippers.

Glass cleaners can be used but with caution, if in doubt contact the manufacturer of the cleaner in question.

Please keep these instructions for aftercare and customer service details.



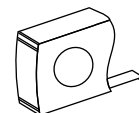
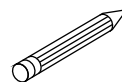
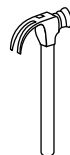
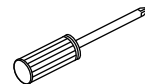
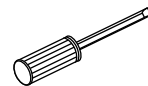
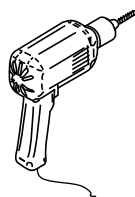
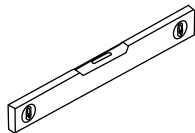
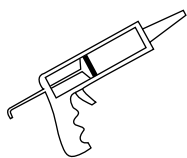







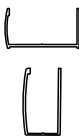
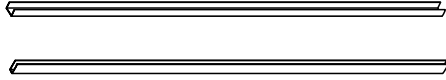



Tools Required

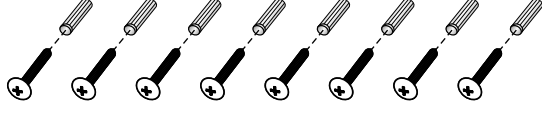

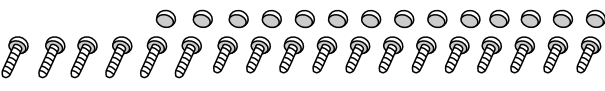
This product is heavy and may require two people to install.

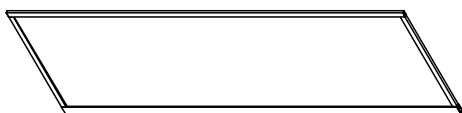

◆ Box Contents:

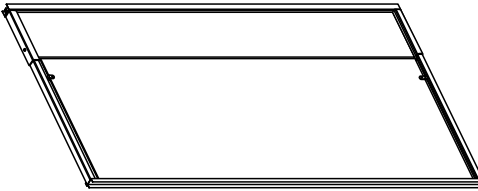
<p>[1] 2xWall Posts</p>			
<p>[2] 1xCorner Post</p>			
<p>[3] 1xInstallation Instruction</p>			
<p>[4] 8xWall Plugs 8xFlat Screws M4x35</p>			
<p>[5] 12xScrews M4x8 6xScrews M4x12 14xScrew Cover Caps</p>			
<p>[6] 2xWater Deflectors</p>			
<p>[7] 1xFixed Panel</p>			
<p>[8] 1xDoor Panel+ Fixed Panel</p>			

◆ Assembly Drawing

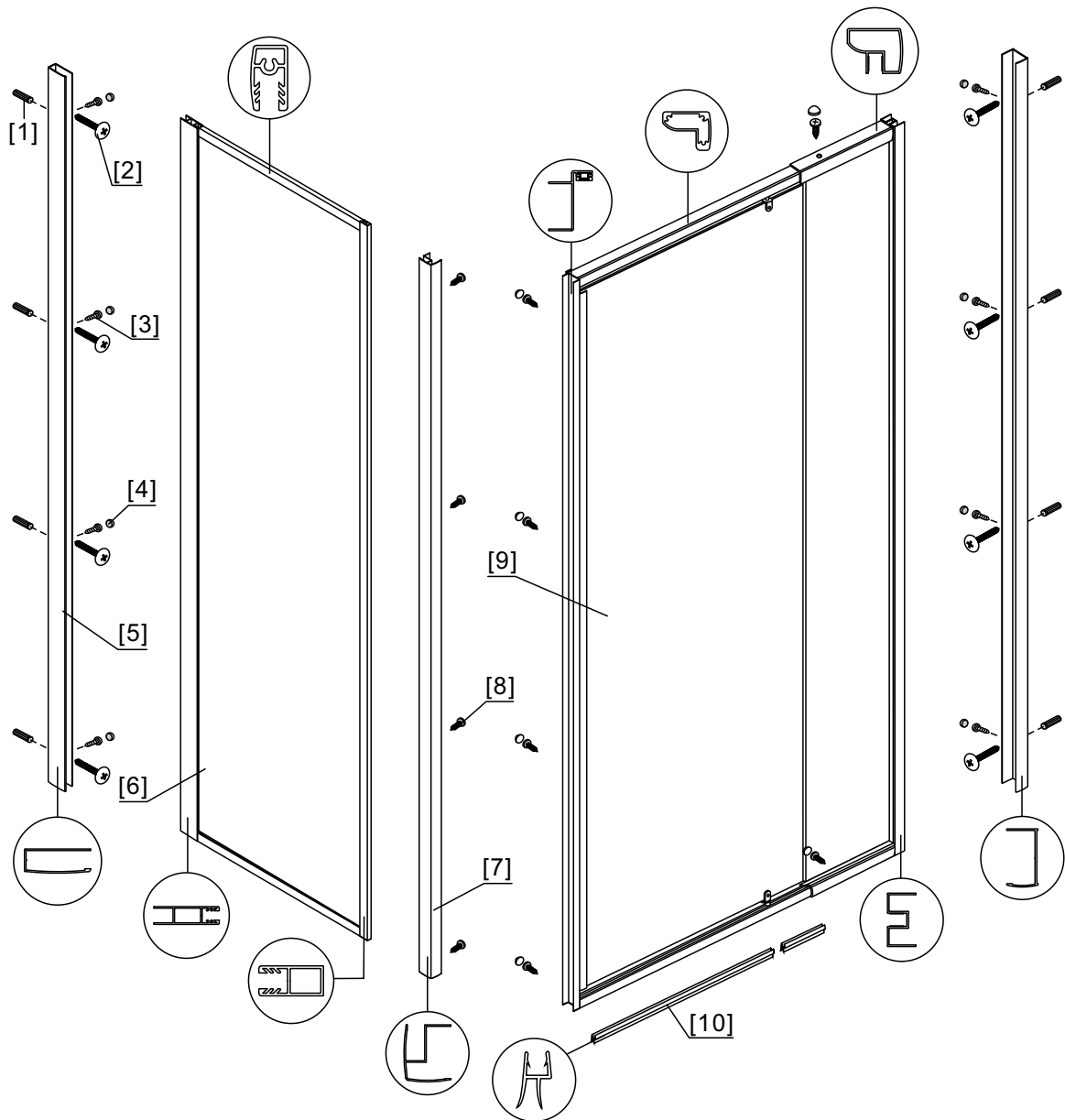

- [1] 8x Wall Plugs
- [2] 8x Flat Screws M4x35
- [3] 12x Screws M4x8
- [4] 14x Screw Cover Caps
- [5] 2x Wall Posts

- [6] 1x Fixed Panel
- [7] 1x Corner Post
- [8] 6x Screws M4x12
- [9] 1x Door Panel + Fixed Panel
- [10] 2x Water Deflectors

◆ Installation Steps:

Step 1

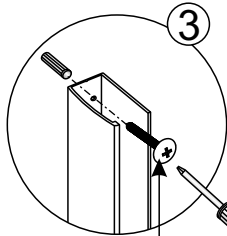
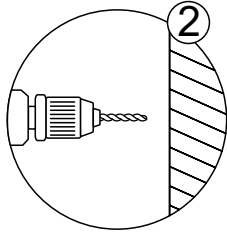
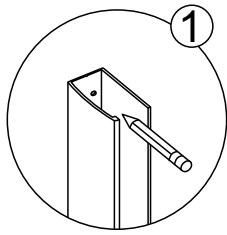

Flat Screw
M4x35

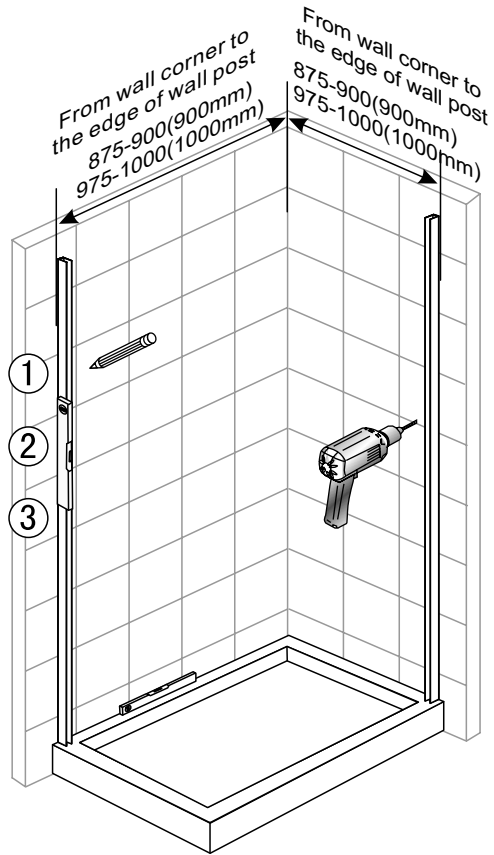

Step 2

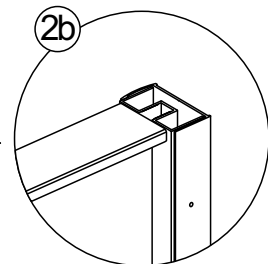
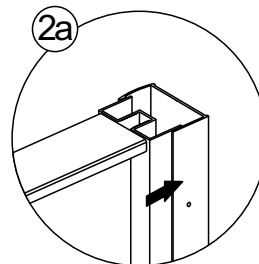
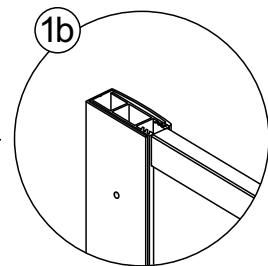
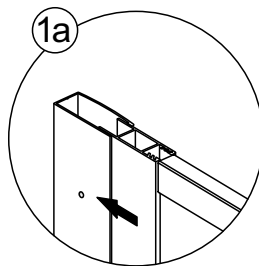
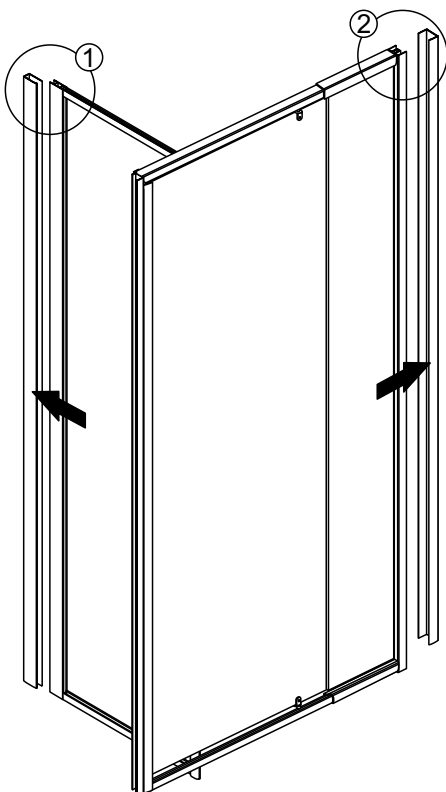

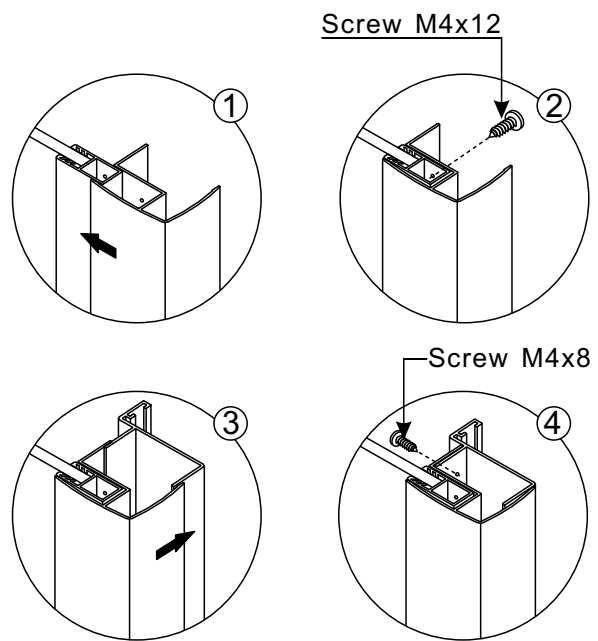
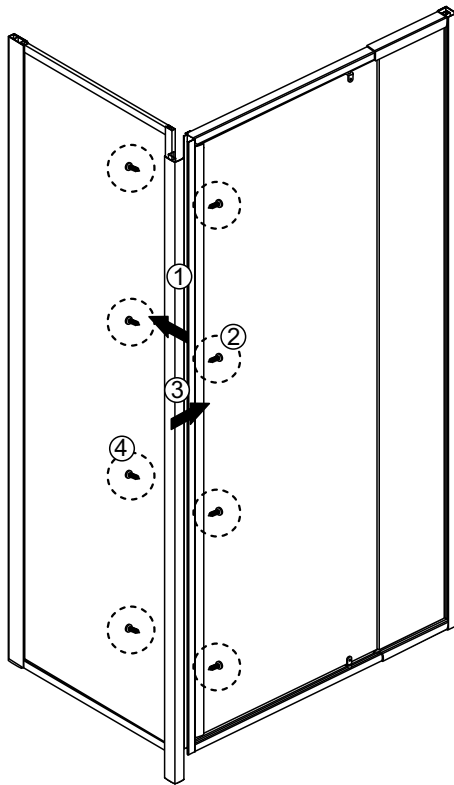

View from inside

Step 3

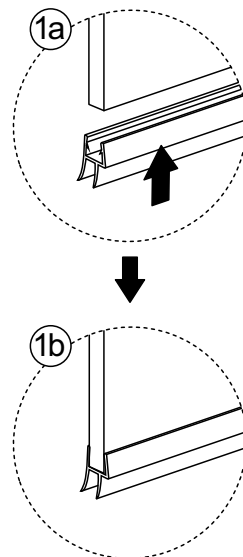
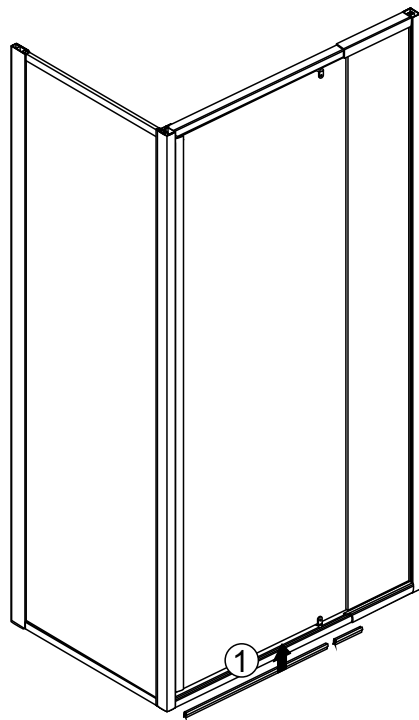

Step 4



 Ensure wall profiles are plumb. Adjust enclosure to be square and level. Wall post and profile should be adjust to square the doors and Ensure open door smooth.

Step 5

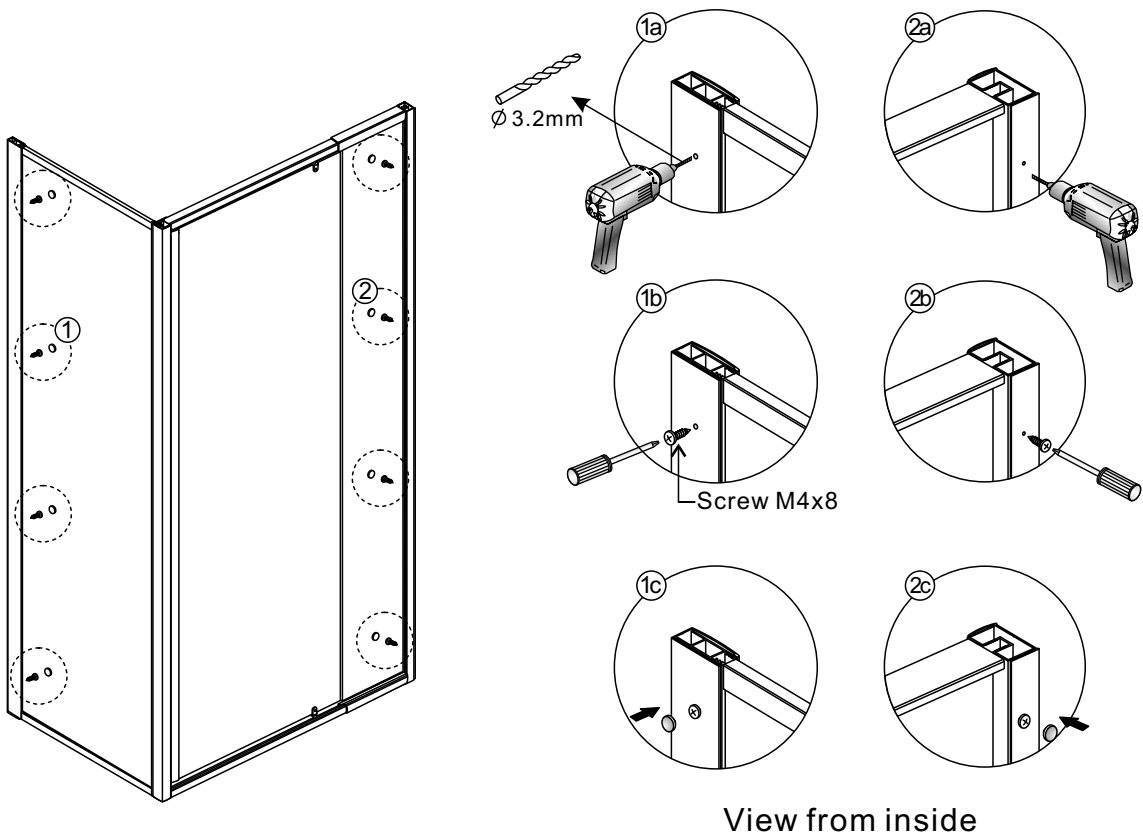

Step 6

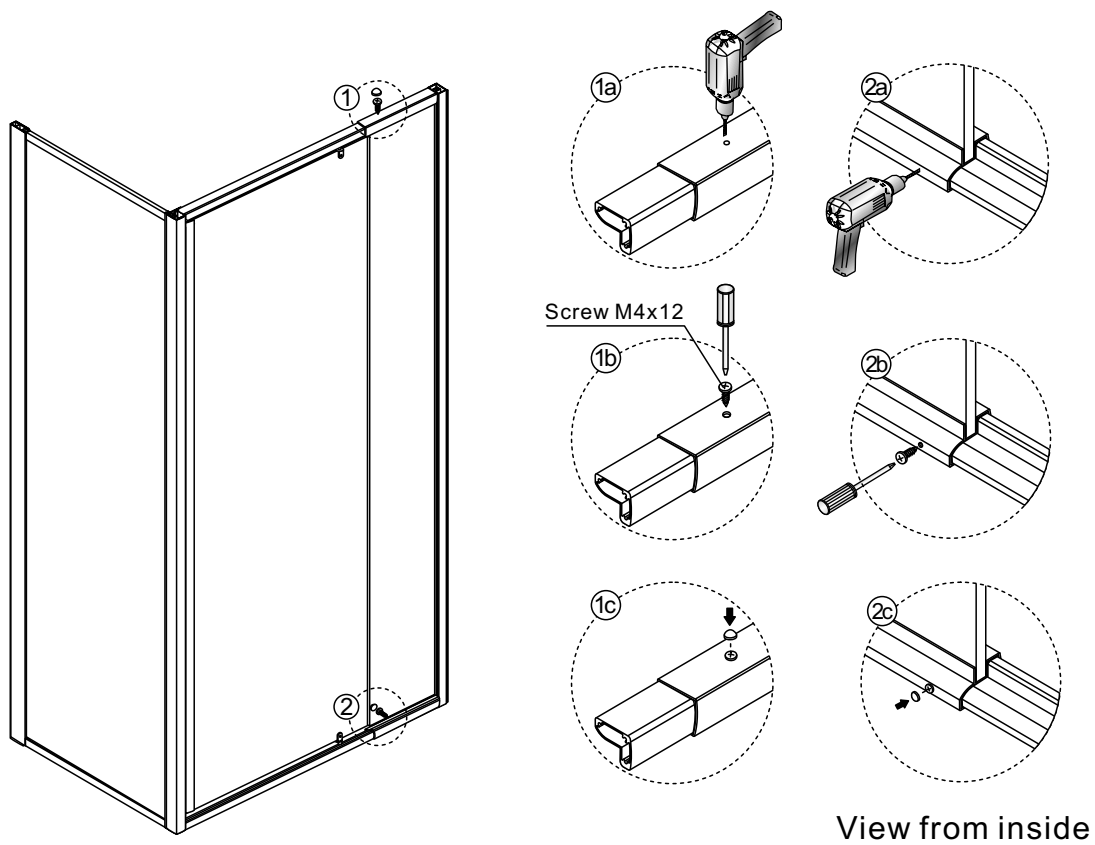

Step 7

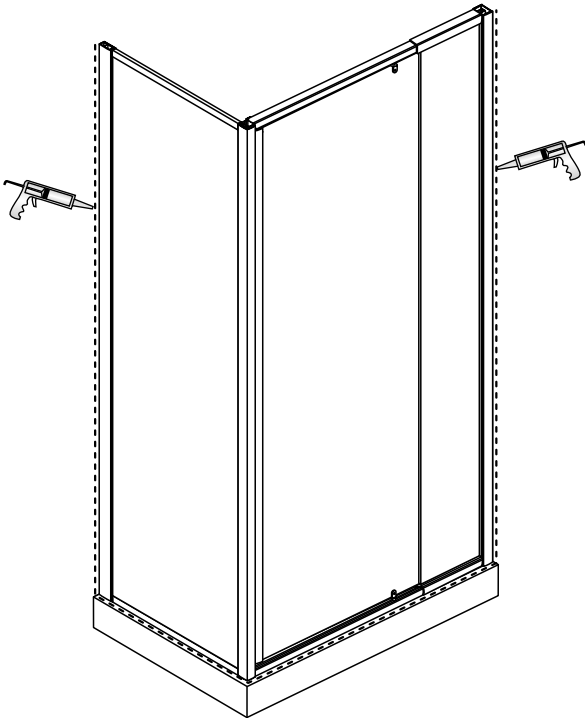

Allow 24 hours for silicone to dry before use.